

APPLICATION NOTE

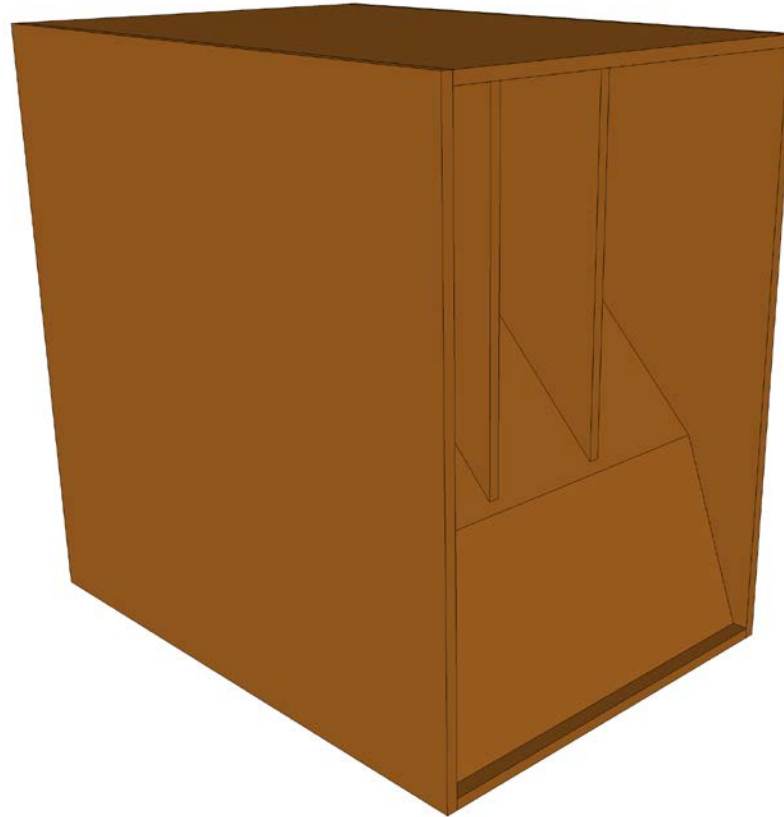

HORN LOADED 18" SUBWOOFER

KEY FEATURES

- High performance 1 x 18" subwoofer system;
- Multiple driver choice is possible;

18TLW3000 woofer key features:

1800 W AES power handling
100 mm (4 In) Tetracoil dual voice coil
Ultra linear suspension behaviour for excellent sound clarity
Low noise forced air cooling design

18LW2500 woofer key features:

1600 W AES power handling
100 mm (4 In) Interleaved voice coil (ISV)
Composite reinforced straight ribbed cone
Ultra linear dual magnet motor design

18LW2400 woofer key features:

1200 W AES power handling
100 mm (4 In) Interleaved voice coil (ISV)
Double Silicon Spider (DSS)
Double Demodulating Rings (DDR)

18TLW3000



General Specifications

Nominal Diameter	460 mm (18 in)
Rated Impedance	8 Ohm
AES Power	1800 W
Program Power	3600 W
Peak Power	10000 W
Sensitivity	95 dB
Frequency Range	30 - 2000 Hz
Power Compression @-10dB	0,6 dB
Power Compression @-3dB	2,0 dB
Power Compression @Full Power	3,4 dB
Max Recomm. Frequency	300 Hz
Recomm. Enclosure Volume	100 - 350 lt. (3,53 - 12,36 cuft)
Minimum Impedance	5,7 Ohm at 25°C
Max Peak To Peak Excursion	45 mm (1.77 in)
Voice Coil Diameter	100 mm (4 in)
Voice Coil winding material	copper
Suspension	Triple roll, Polycotton
Cone	Curvilinear fiberglass loaded cellulose

Thiele Small Parameters

Fs	33 Hz
Re	4,6 Ohm
Sd	0,1225 sq. mt. (189,88 sq. in.)
Qms	13,00
Qes	0,42
Qts	0,41
Vas	185 lt. (6.53 cuft)
Mms	266 gr. (0,59 lb)
BL	24,5 Tm
Linear Mathematical Xmax	± 12 mm (± 0,47 in)
Le (1kHz)	1,80 mH
Ref. Efficiency 1W@1m (half space)	94,0 dB

KEY FEATURES

18LW2400



General Specifications

Nominal Diameter	460 mm (18 in)
Rated Impedance	8 Ohm
AES Power	1200 W
Program Power	2400 W
Peak Power	7000 W
Sensitivity	98 dB
Frequency Range	31 - 2500 Hz
Power Compression @-10dB	0,7 dB
Power Compression @-3dB	1,5 dB
Power Compression @Full Power	2,2 dB
Max Recomm. Frequency	500 Hz
Recomm. Enclosure Volume	130 - 350 lt. (4,59 - 12,36 cuft)
Minimum Impedance	6,3 Ohm at 25°C
Max Peak To Peak Excursion	50 mm (1,97 in)
Voice Coil Diameter	100 mm (4 in)
Voice Coil winding material	copper
Suspension	Triple roll, Polycotton
Cone	Straight ribbed, fiberglass reinforced cellulose

Thiele Small Parameters

Fs	35 Hz
Re	5 Ohm
Sd	0,1225 sq. mt. (189,88 sq. in.)
Qms	7,2
Qes	0,32
Qts	0,31
Vas	230 lt. (8,12 cuft)
Mms	192 gr. (0,42 lb)
BL	25,6 Tm
Linear Mathematical Xmax	± 9,5 mm (± 0,38 in)
Le (1kHz)	1,35 mH
Ref. Efficiency 1W@1m (half space)	96,7 dB

18LW2500



General Specifications

Nominal Diameter	462 mm (18 in)
Rated Impedance	8 Ohm
AES Power	1600 W
Program Power	3200 W
Peak Power	7200 W
Sensitivity	95 dB
Frequency Range	30 Hz - 1000 Hz
Power Compression @-10dB	0,6 dB
Power Compression @-3dB	2,2 dB
Power Compression @Full Power	3,3 dB
Max Recomm. Frequency	250 Hz
Recomm. Enclosure Volume	160-350 lt. (4,59 - 12,37 cuft)
Minimum Impedance	6,1 @ 25°
Max Peak To Peak Excursion	70 mm (2,76 in)
Voice Coil Diameter	100 mm (4 in)
Voice Coil winding material	Copper wire
Suspension	Triple roll, Heavy Polycotton
Cone	Curved ribbed fiber loaded cellulose

Thiele Small Parameters

Fs	34 Hz
Re	4,9 Ohm
Sd	0,113 sq.m (175,15 sq.in)
Qms	22
Qes	0,34
Qts	0,33
Vas	135 lt. (4,76 cu.ft)
Mms	290 gr. (0,64 lb)
BL	30 Tm
Linear Mathematical Xmax	±14 mm (±0,55 in)
Le (1kHz)	2,87 mH
Ref. Efficiency 1W@1m (half space)	93,8 dB

KEY FEATURES

- The enclosure should be made of Baltic birch plywood (15mm thickness)
- Bolts are M6x35mm (M6 T-Nuts recommended)
- Handling, rigging and connectors are user's choice

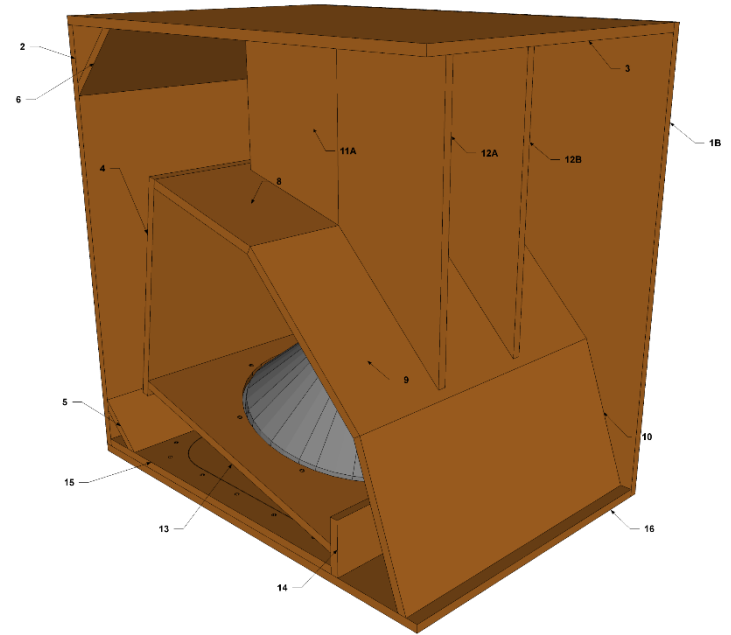
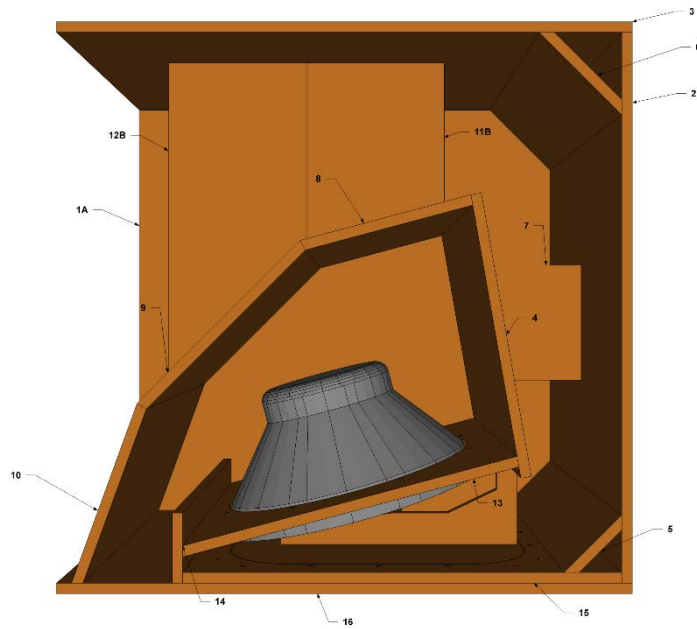

KEY FEATURES

- It's recommended to well damp the cabinet interior (an high density dampening material, such as Dacron or other synthetic fibers, is required for better performance)
- You should use the image as an example

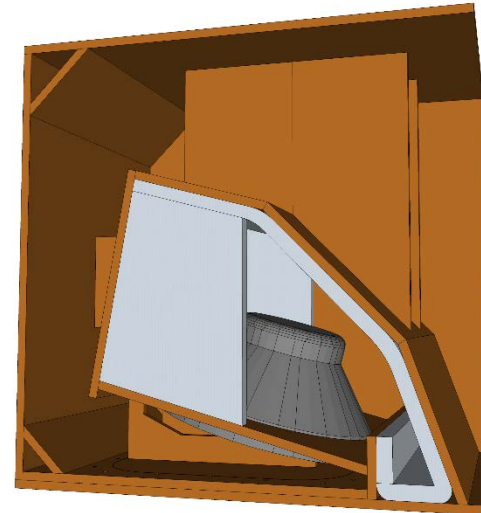
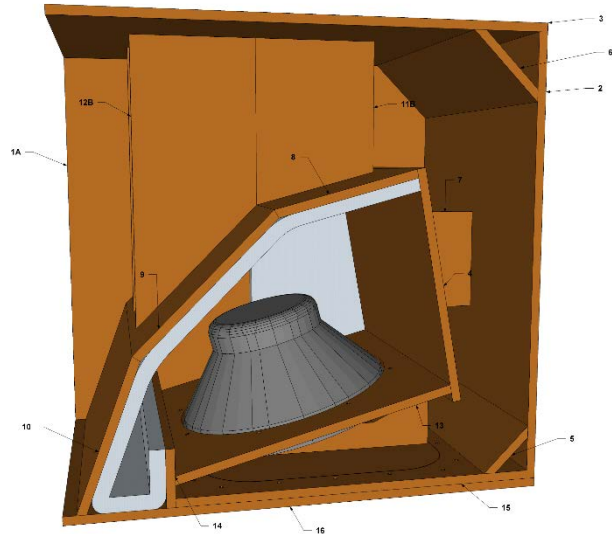
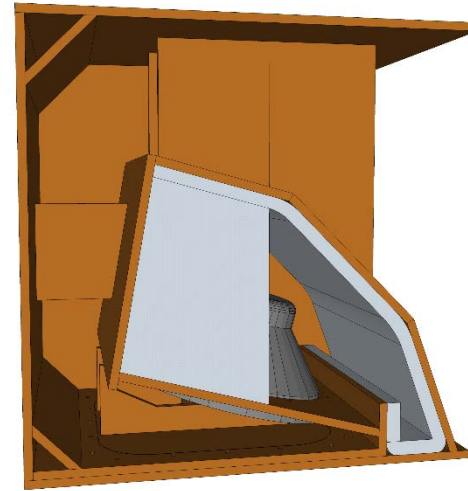

UNFILTERED MAGNITUDE RESPONSE, 2.83V/1M AND RELATIVE PHASE RESPONSE WITH 18TLW3000

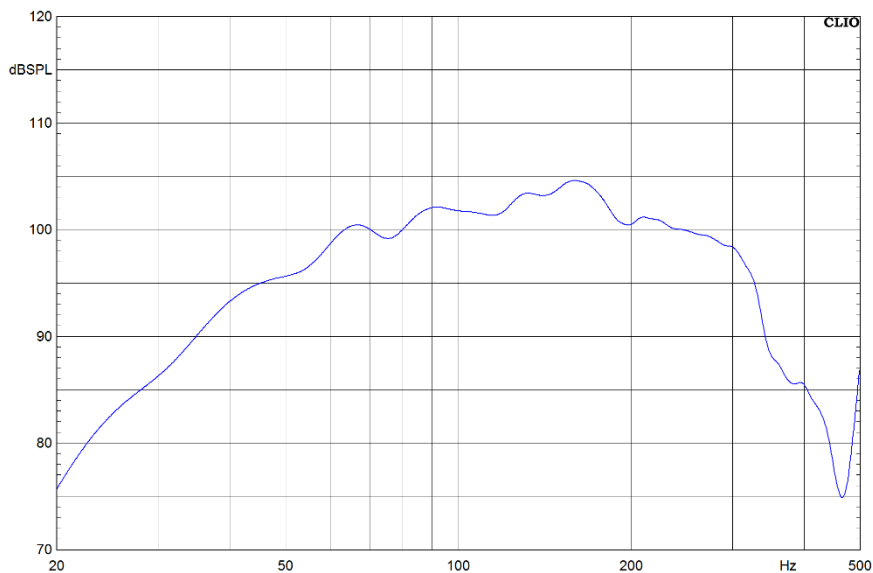

MAGNITUDE RESPONSE

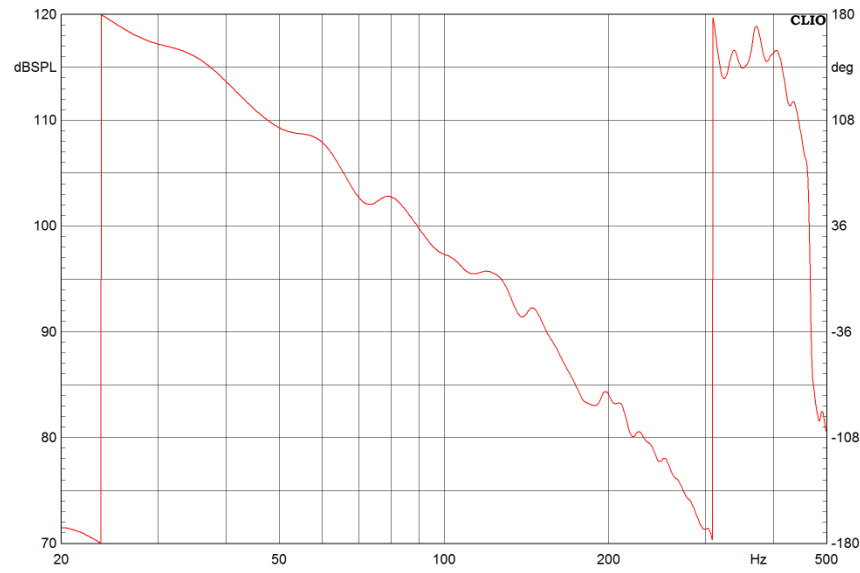

PHASE RESPONSE

IMPEDANCE RESPONSE WITH 18TLW3000

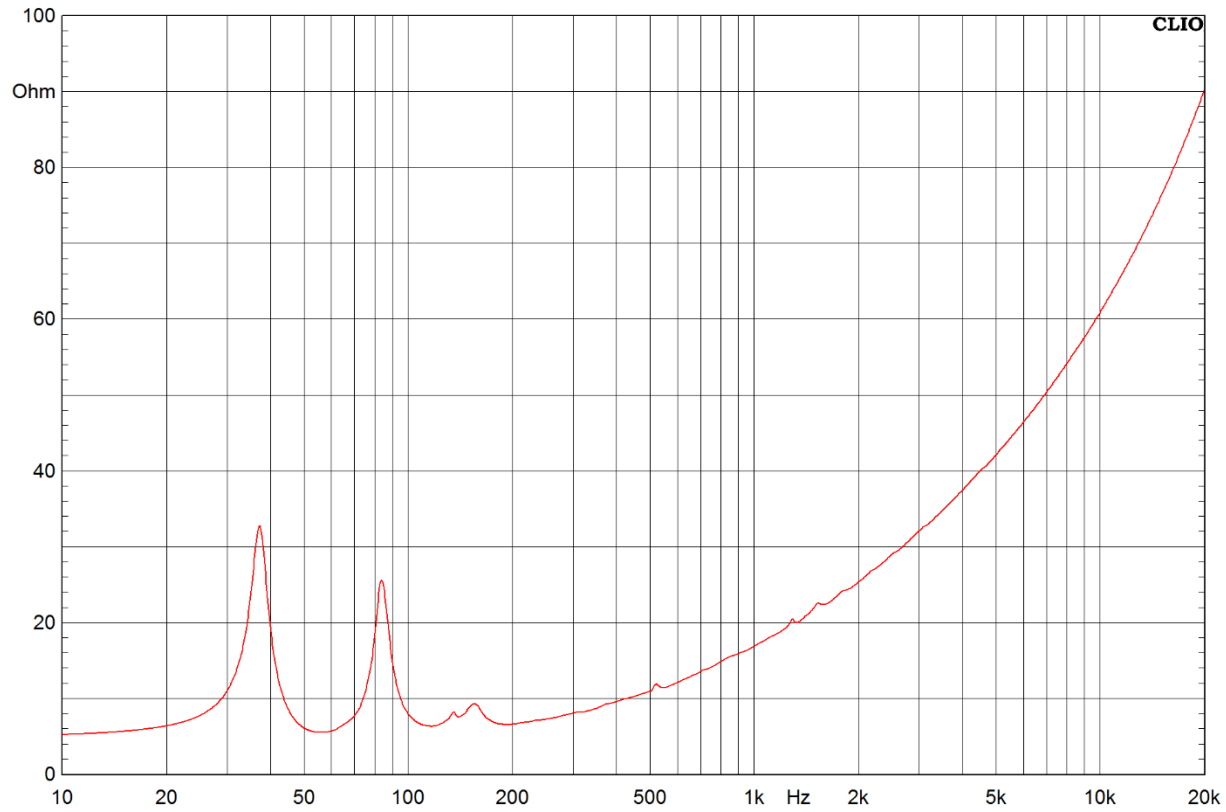

FILTERED MAGNITUDE RESPONSE, 2.83V/1M WITH 18TLW3000

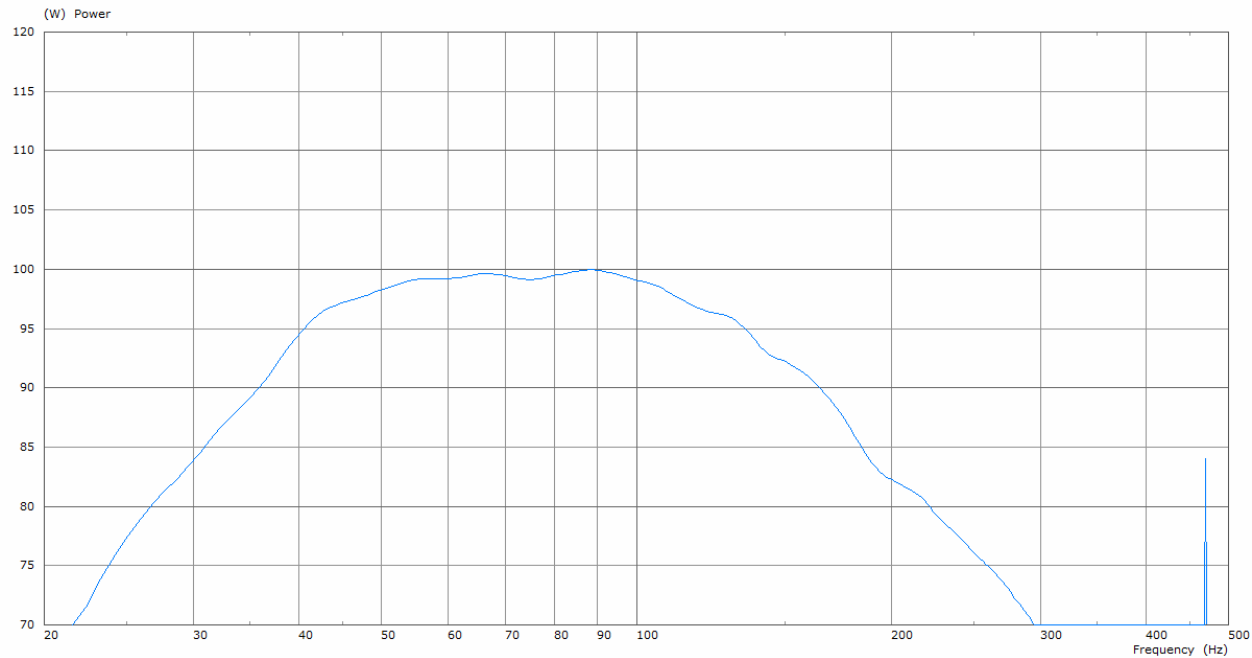

EQUALIZATION SETTINGS SUGGESTION

High Pass: Butterworth 12dB/Oct 45Hz
Parametric EQ: $f_o = 150$ / -9dB / $Q = 1$
Parametric EQ: $f_o = 90$ / -3dB / $Q = 3$
Parametric EQ: $f_o = 50$ / 1dB / $Q = 2$
Low Pass: Butterworth 24dB/Oct 120Hz

GAIN = 3dB

UNFILTERED MAGNITUDE RESPONSE, 2.83V/1M AND RELATIVE PHASE RESPONSE WITH 18LW2500

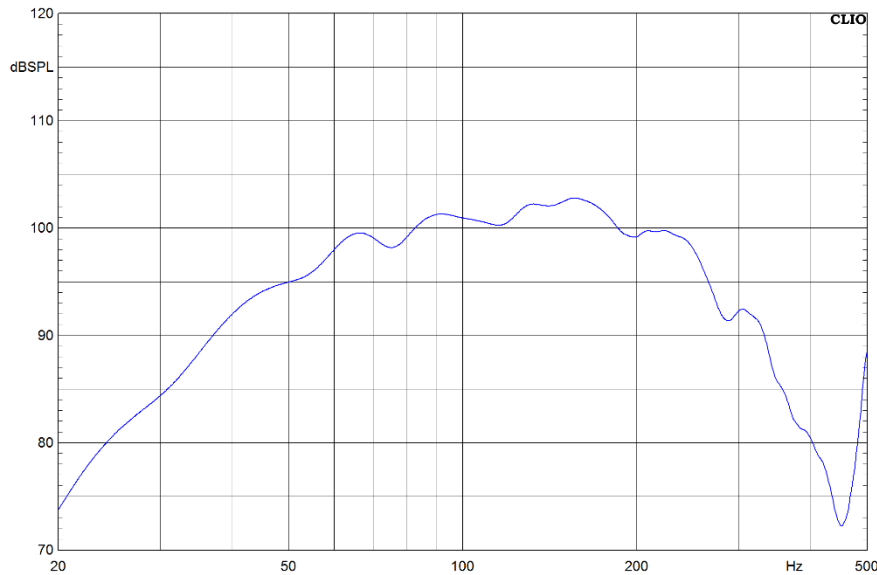

MAGNITUDE RESPONSE

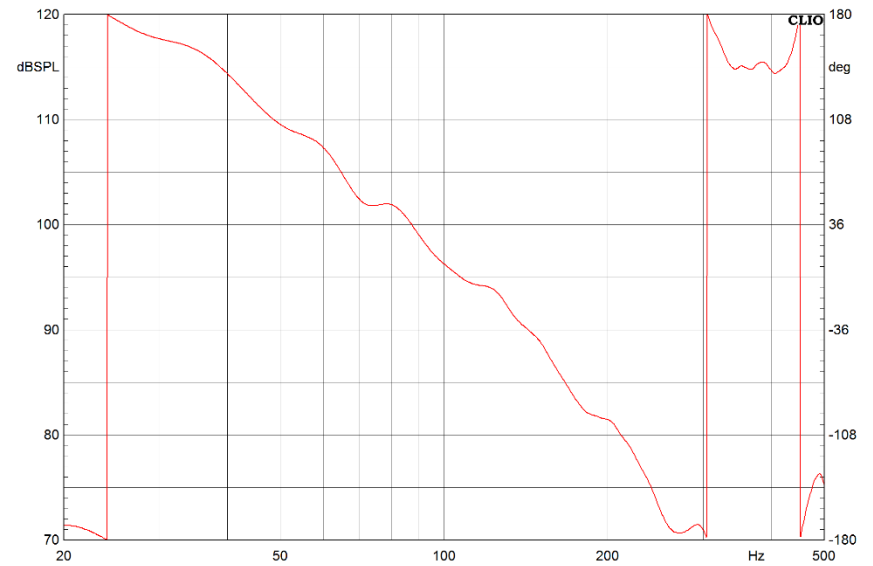

PHASE RESPONSE

IMPEDANCE RESPONSE WITH 18LW2500

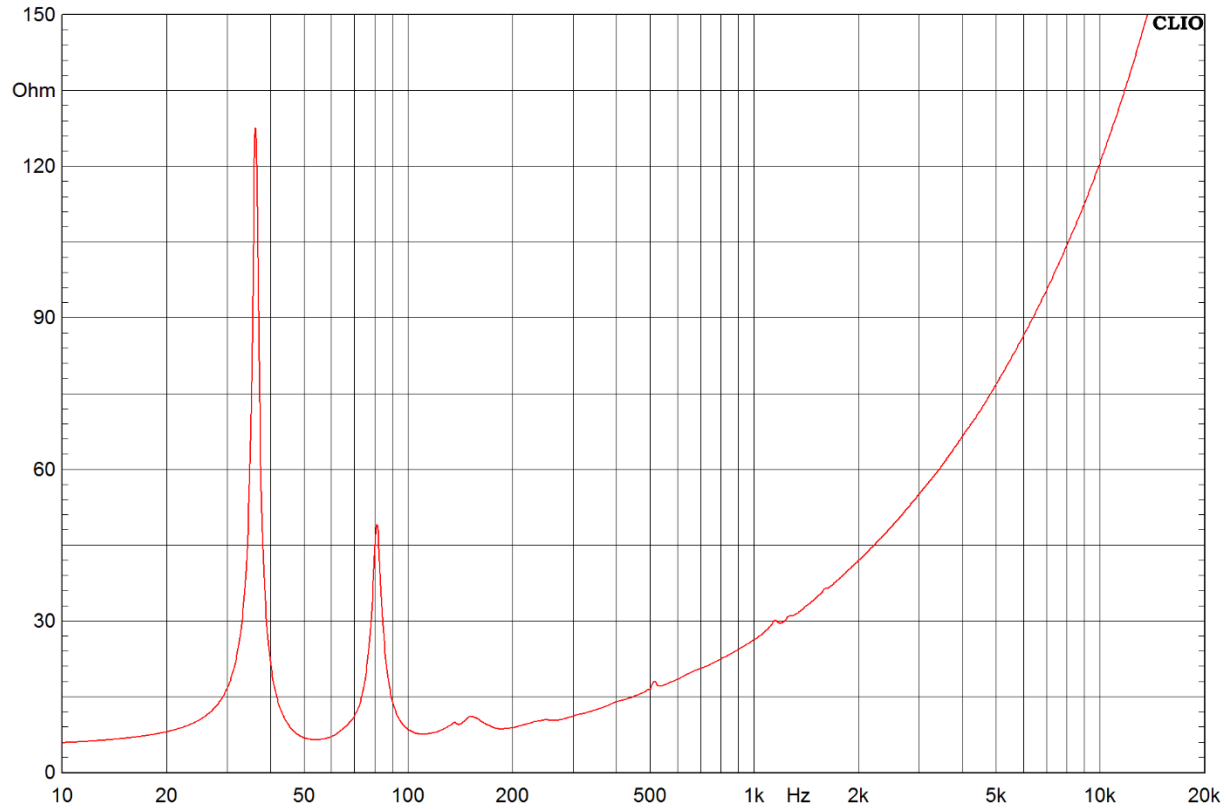

FILTERED MAGNITUDE RESPONSE, 2.83V/1M PHASE WITH 18LW2500

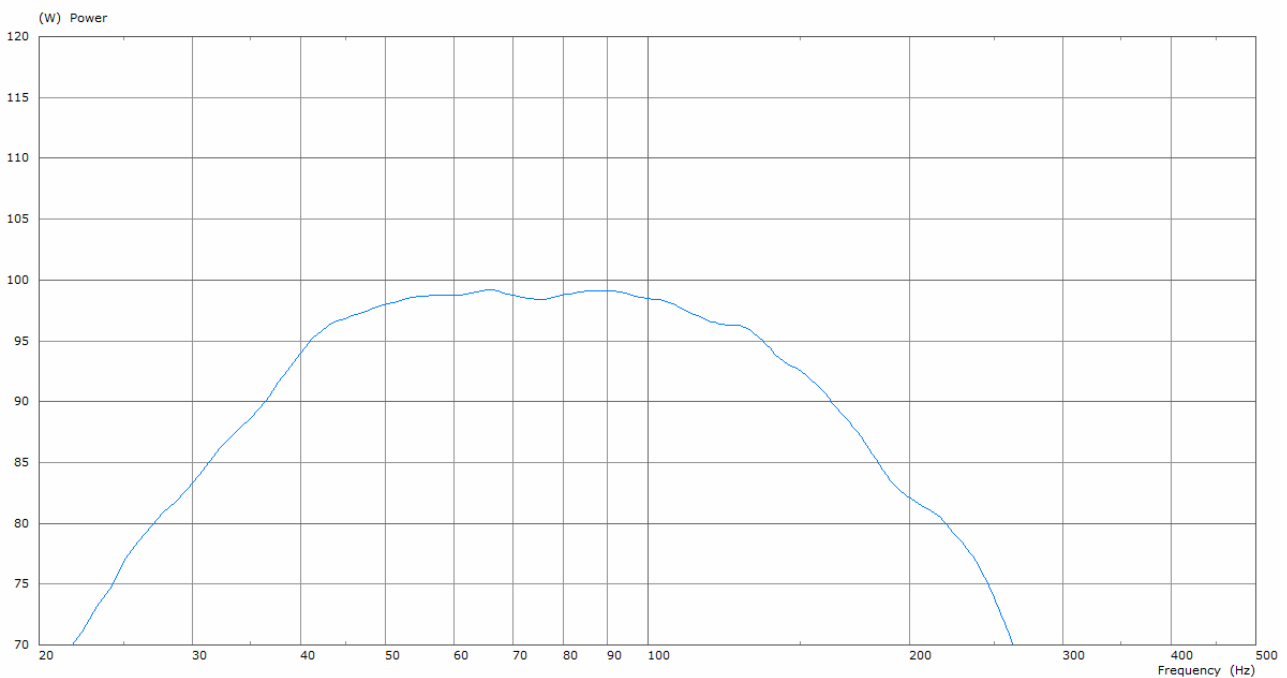

EQUALIZATION SETTINGS SUGGESTION

- High Pass: Butterworth 12dB/Oct 45Hz
- Parametric EQ: $f_o = 150$ / -7dB / $Q = 1$
- Parametric EQ: $f_o = 90$ / -4dB / $Q = 3$
- Parametric EQ: $f_o = 50$ / 1dB / $Q = 2$
- Low Pass: Butterworth 24dB/Oct 120Hz

GAIN = 3dB



EXPLODED VIEW

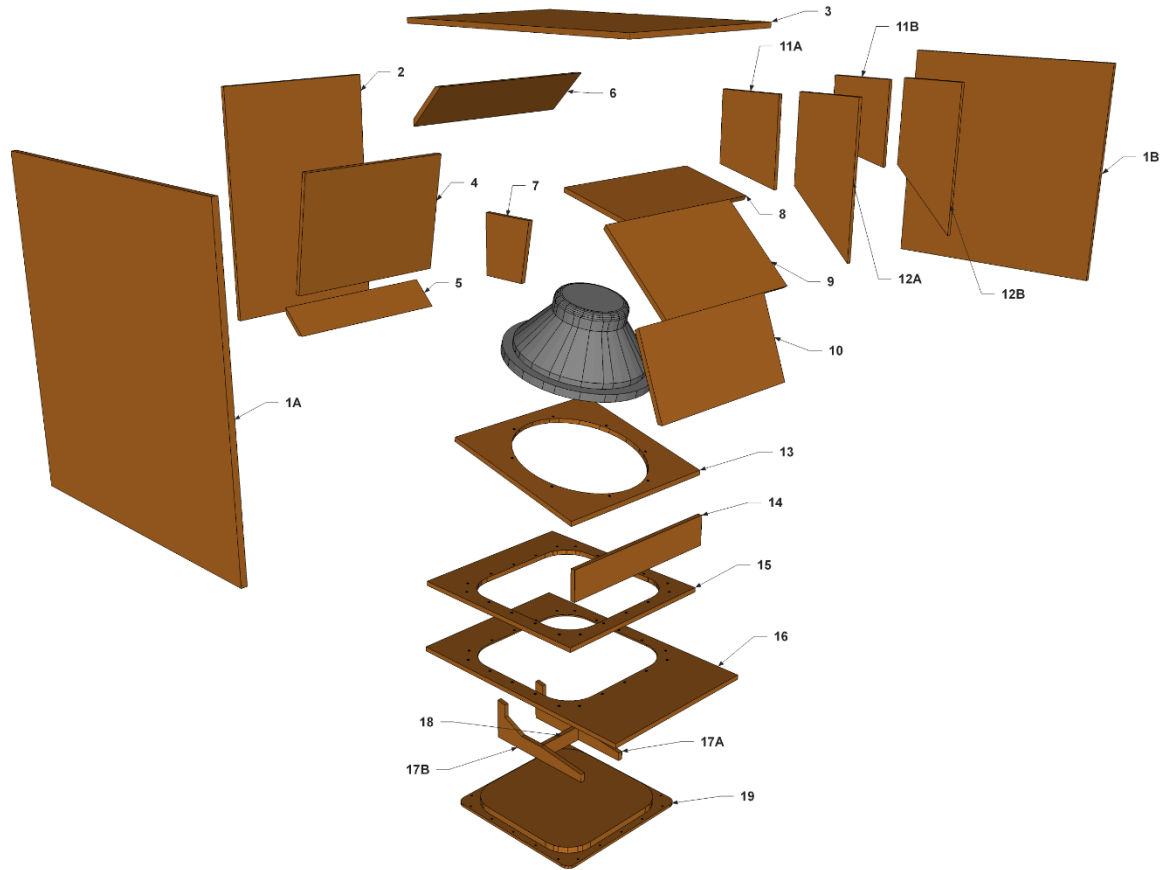

SIDE VIEW

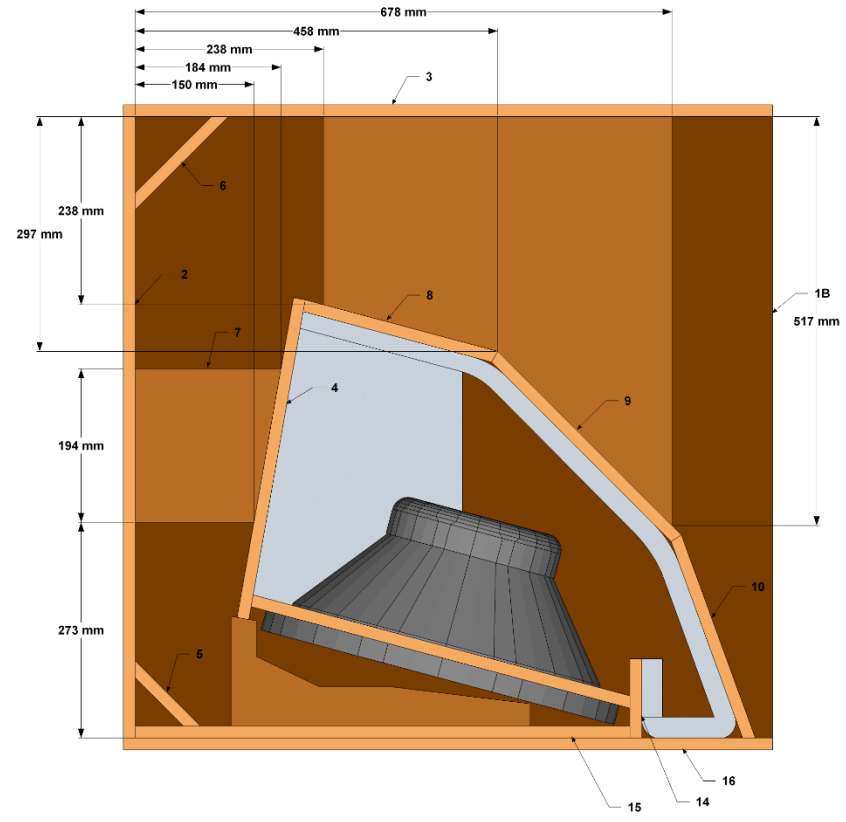
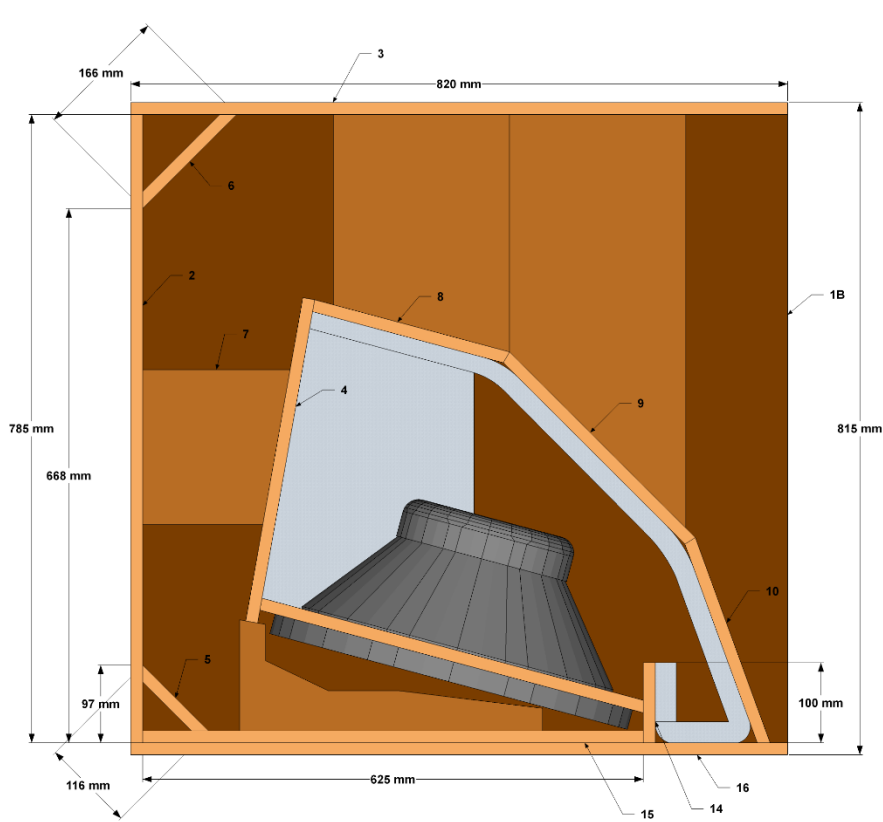

FRONT SIDE

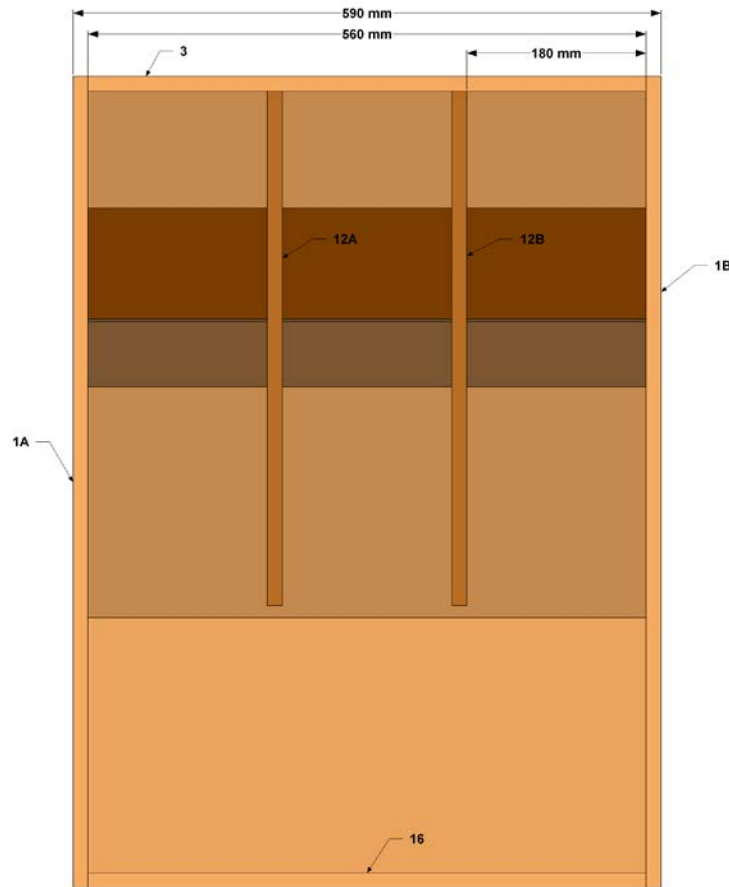

DETAILS: HORN CONSTRUCTION



DETAILS: REAR CONSTRUCTION

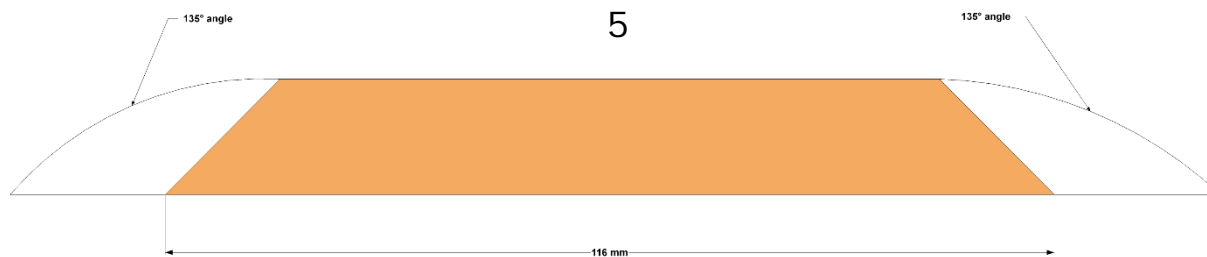
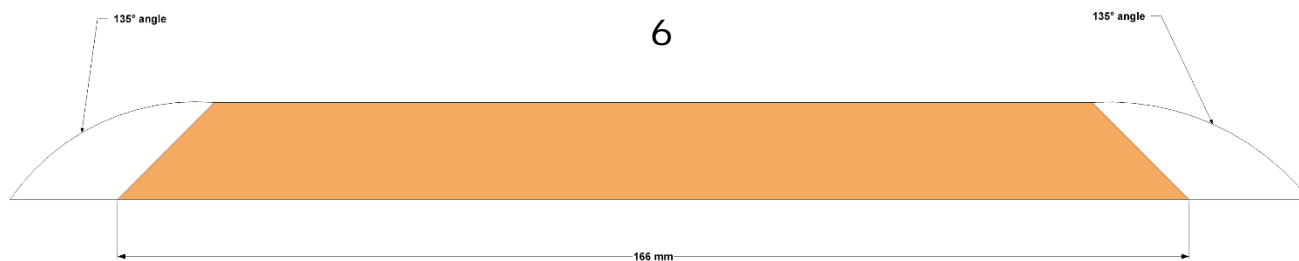

DETAILS: WOOFER

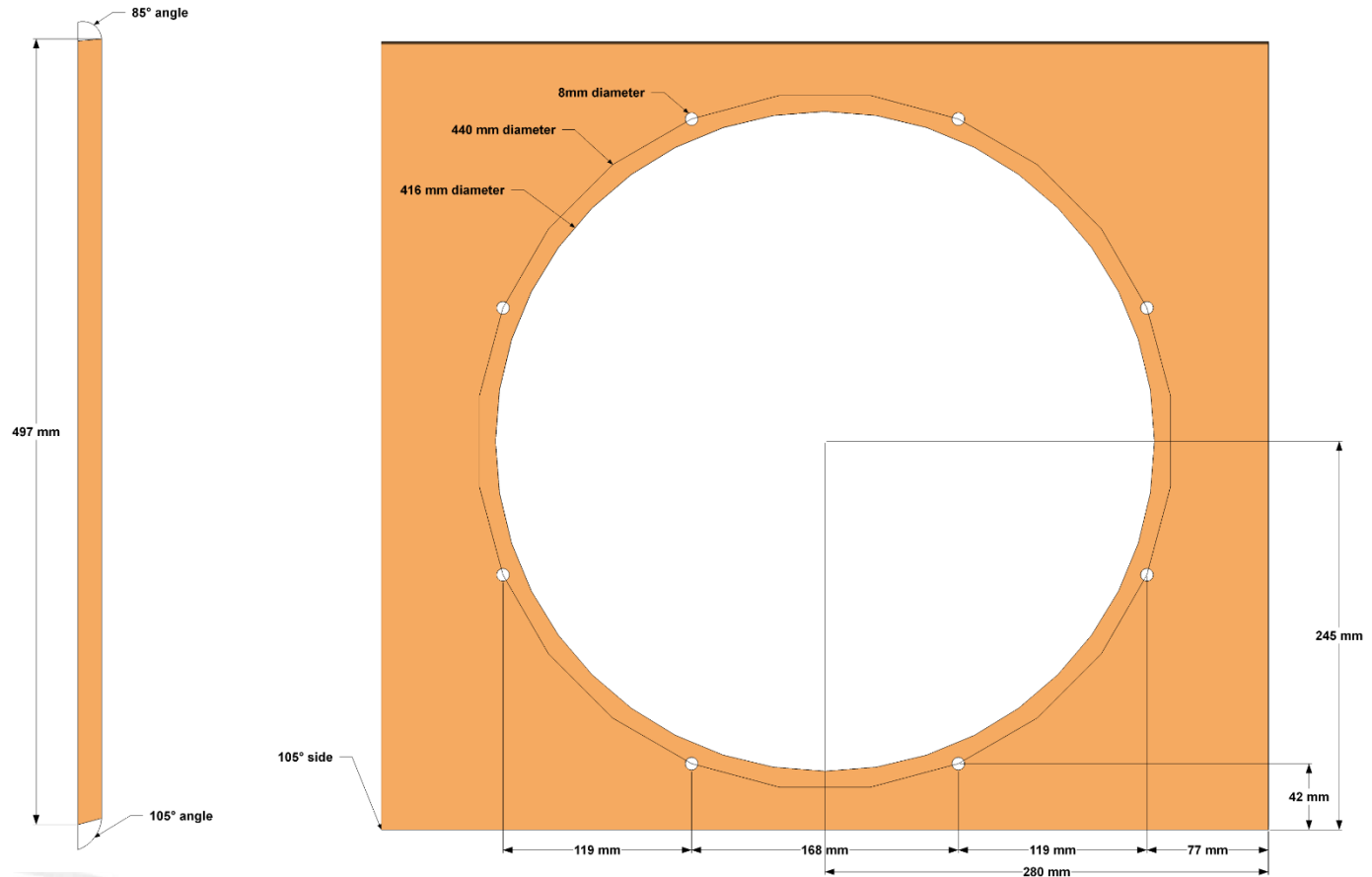

DETAILS: ACCESS PANEL

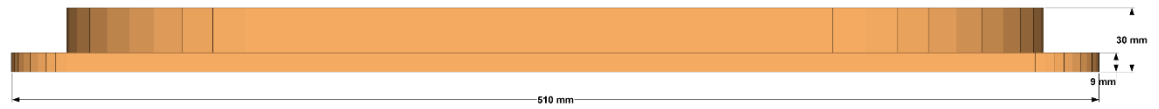
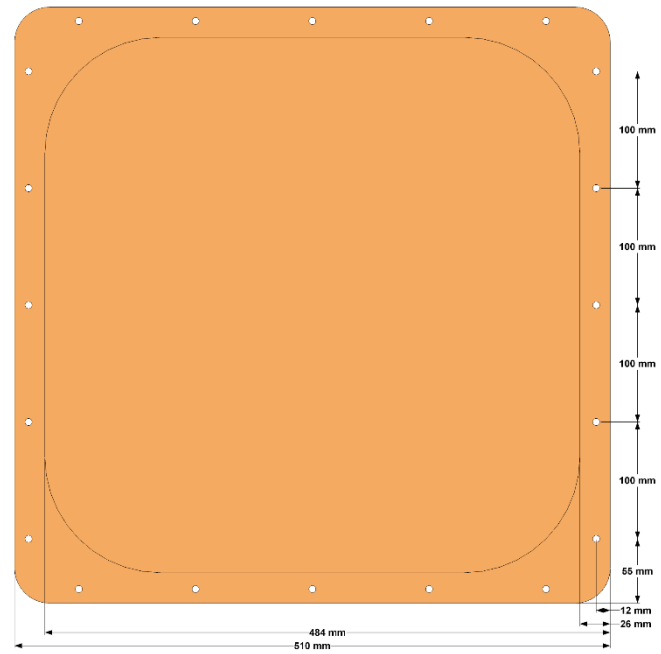
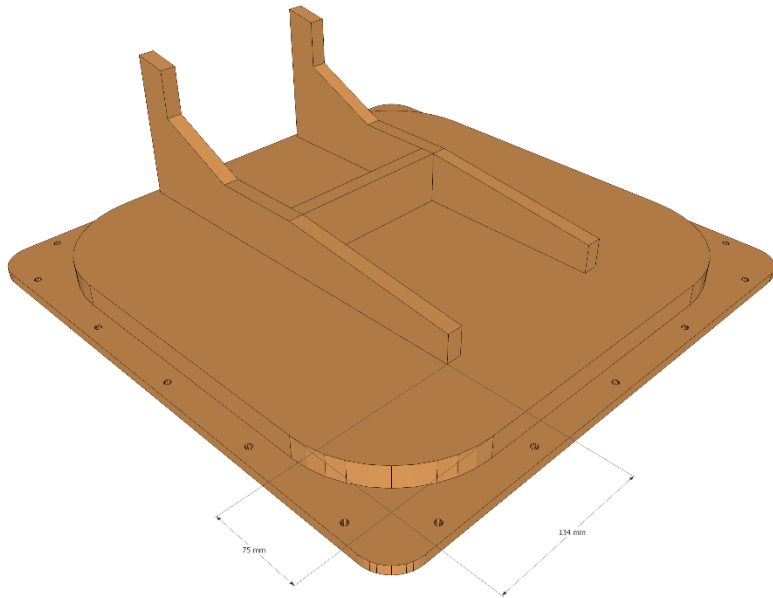

DETAILS: ACCESS PANEL REINFORCEMENT

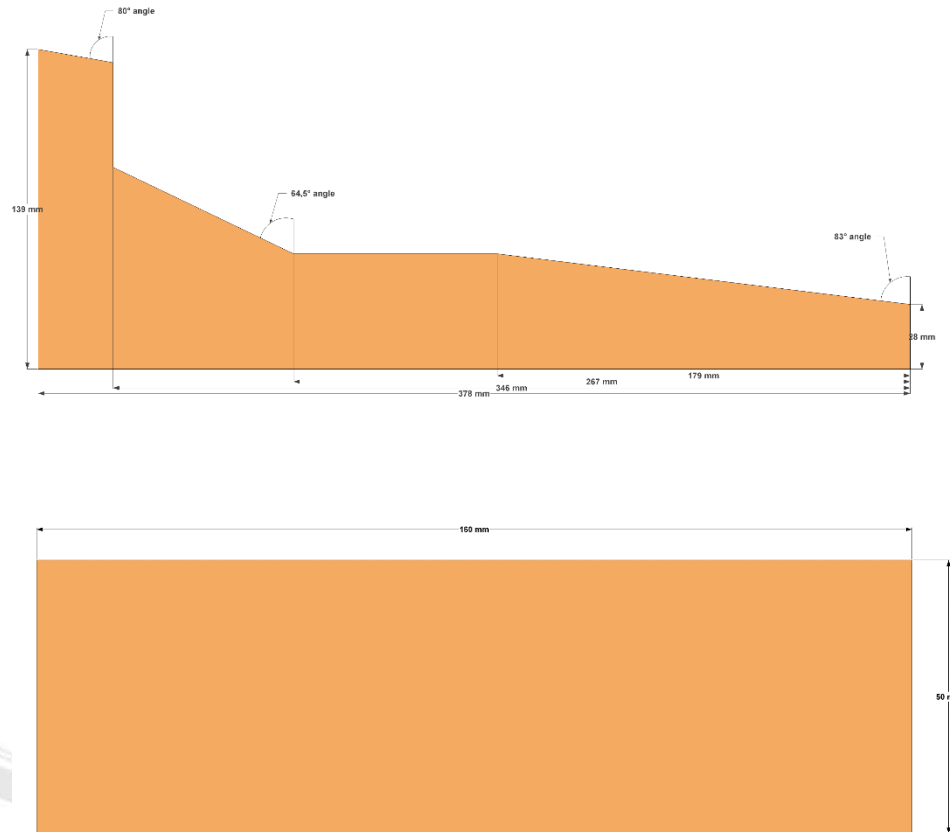

DETAILS: ACCESS PANEL HOUSING

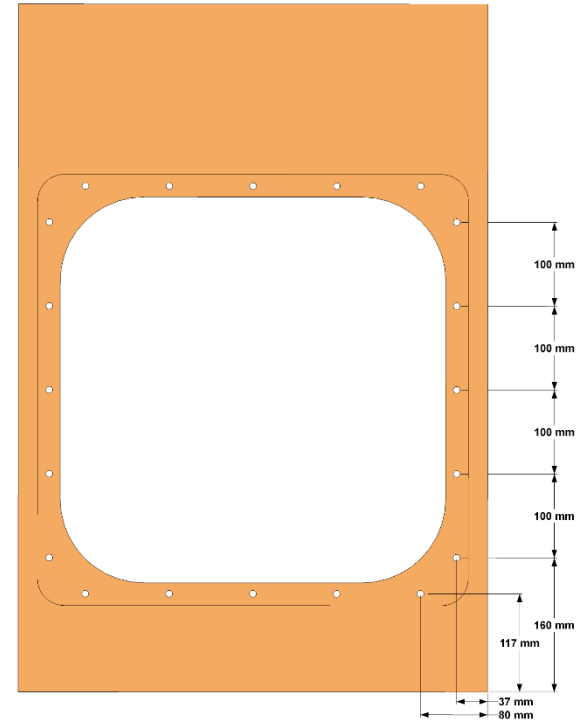
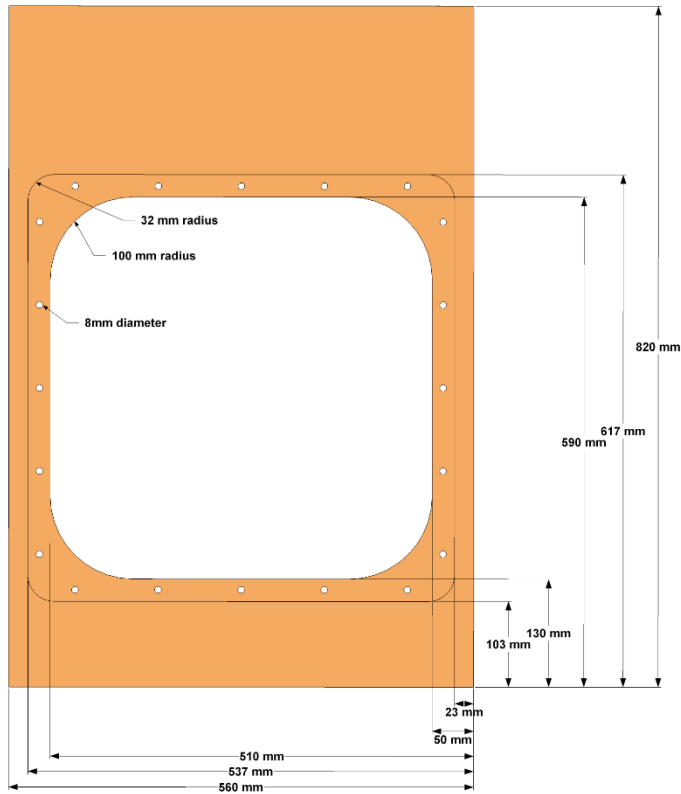

DETAILS: ACCESS PANEL HOUSING

